







Ravaglioli

COMPANY WITH
QUALITY SYSTEM
CERTIFIED BY DNV GL
= ISO 9001 =

- DUE COLONNE ELETTROIDRAULICI 
- ELECTRO-HYDRAULIC 2 POST LIFTS 
- ELEKTROHYDRAULISCHE 2-SÄULEN HEBEBÜHNEN 
- 2 COLONNES ELECTRO-HYDRAULIQUES 
- DOS COLUMNAS ELECTRO-HYDRAULICOS 

KPH

370.55

LIKTA

370.70

LIKTA



*For long wheel-base vehicles
5500 kg - 7000 kg*





KPH370.55LIKTA / 5500 kg
KPH370.70LIKTA / 7000 kg

Modello ideale per il sollevamento di furgoni e furgonati a passo lungo incluso Mercedes Sprinter e VW Crafter. Versioni con due bracci lunghi a 3 stadi e due a 4 stadi, consentono caricabilità ottimale anche per le autovetture.

Model ideal to lift long wheel-base vans like Mercedes Sprinter and VW Crafter. Models equipped with two long 3-stage arms and two long 4-stage arms, to allow easy lifting of large cars.

Modell ideal zum Heben von Lieferwagen auch mit langem Radstand wie Mercedes Sprinter and VW Crafter. Ausführungen mit zwei zweifach und zwei dreifach ausziehbaren langer Armen, um eine optimale Aufnahme von PKWs auch zu garantieren.

Élévateur idéal pour le levage de fourgons à châssis long inclus les Mercedes Sprinter and VW Crafter. Versions équipées de deux bras longs à 3 étages et deux à 4 étages pour garantir aussi le levage optimal de voitures.

Modelo ideal sea para el levantamiento de furgonetas normales y de chasis largo incluido Mercedes Sprinter and VW Crafter. Versiones con dos brazos largos de 3 extensiones y dos de 4 extensiones, por el levantamiento también de turismos.

Dispositivo di appoggio meccanico ad inserimento automatico a garanzia della massima sicurezza in fase di stazionamento.

Mechanical safety latch with automatic engagement ensuring maximum safety when lift is in standing position.

Mechanische Stützvorrichtung mit automatischer Einschaltung um eine maximale Sicherheit im aufgehobenen Zustand zu garantieren.

Dispositif de soutien mécanique avec enclenchement automatique pour garantir la sécurité totale pendant le stationnement.

Dispositivo de apoyo mecánico de funcionamiento automático como garantía de la máxima seguridad en la fase de estacionamiento.

I cavi non portanti garantiscono la sincronizzazione.

Synchronization cables grant the levelling of the two carriages.

Gleichlauf mittels Seile (nicht tragend).

La synchronisation est garantie grace à un câble d'acier non-portant.

Los cables no portantes garantizan la sincronización.

In ciascuna colonna è presente un pistone di sollevamento che non richiede alcuna manutenzione.

Each column features a maintenance-free lifting cylinder.

Wartungsfreie Zylinder in jeder Säule.

Chaque colonne est équipée d'un vérin conçu pour un fonctionnement "sans entretien."

En cada columna está presente un pistón de elevación que no requiere mantenimiento alguno.



Altezza regolabile
Adjustable height
Justierbare Höhe
Hauteur réglable
Altura regulable

KPH370.55LIKTA

4950 mm
4850 mm

KPH370.70LIKTA

5016 mm
4816 mm
4616 mm

VARKPH370.55LIKTA/T
VARKPH370.70LIKTA/T

Versione a richiesta con:
Version on demand featuring:
Version auf Anfrage:
Version sur demande avec:
Versión bajo pedido con:

1

Comando singolo per salita/discesa

Single lifting/lowering control

Drehweschalter zum Hoch- und Runterfahren

Commande unique pour montée-descente

Mando individual para bajada/subida

2

Sgancio arresti pneumatico

Pneumatic release of locking devices

Pneumatische Entriegelung

Décrochage pneumatique des arrêts

Desenganche neumático de los trinquetes de seguridad

3

Centralina in alto

Control unit on the upper part of the column

Hydraulikaggregat oben

Unité hydraulique en haut

Centralita posicionada en la parte alta de la columna

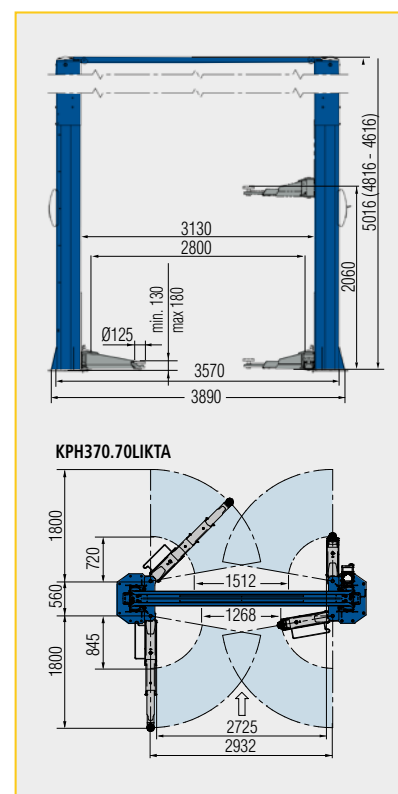
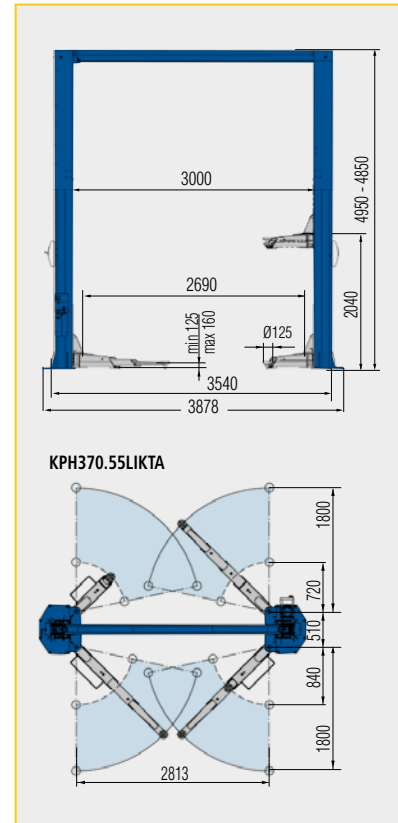



OPTIONS

S370A7

S370A8

S370A15

Only applicable to
KPH370.70LIKT

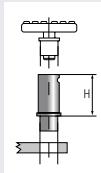

H=80mm
4xkit



H=140mm
4xkit



H=200mm
4xkit



Distanziali / Spacers / Abstandstücke / Rehausses / Espesores



Quick fit sistem

S370A16 → S370A7 - S370A8 - S370A15
Ø 60mm

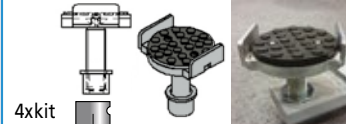

4xkit

Supporti presa telaio
Frame adapters
Halierungen für
Chassisaufnahme
Supports prise sur
chassis
Espesores de agarre
sobre chasis



S5.337 A2 2xkit
Supporti presa telaio
Frame adapters
Halierungen für Chassisaufnahme
Supports prise sur chassis
Espesores de agarre sobre chasis



Kit supporto distanziali
Spacer supports
Satz Halierung Distanzhülsen
Supports pour rehausses
Soportes para espesores

S370A14 → S370A7 - S370A8 - S370A15
Ø 60mm

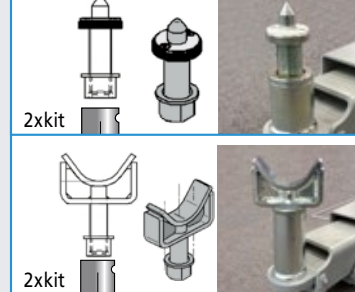

2xkit

2xkit

**For Mercedes Sprinter,
VW LT+Crafter**
Supporti
Adapters
Halierungen
Supports
Adaptadores de agarre

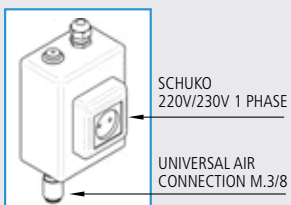

S374A2
1 PHASE + AIR
Air / Electric utility box

SCHUKO
220V/230V 1 PHASE

UNIVERSAL AIR
CONNECTION M.3/8

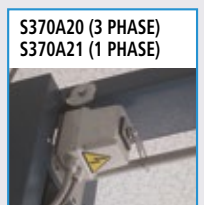

S370A20 (3 PHASE)
S370A21 (1 PHASE)

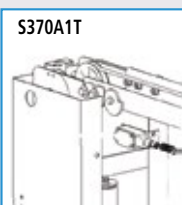

S370A1T

Finecorsa
Limit switch
Endabschalter
Fin de course
Final de carrera

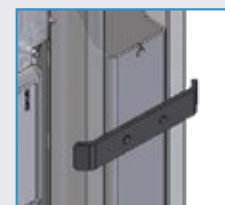

S370A5 2xkit
Set parasportelli
Set of door protections
Satz Türanschläge
Kit protection portes
Juego de protecciones
para puertas.



Distributed by:



1300 30 40 60 - www.efi.com.au

DRD21U (11)

Le caratteristiche tecniche e gli allestimenti presentati in questo prospetto possono subire variazioni. Le immagini riprodotte non sono vincolanti.
Technical data and composition presented in this catalogue may vary. Pictures reproduced are only indicative.
Die techn. Daten und die Ausrüstungen, die in diesem Prospekt enthalten sind, können Änderungen erfahren. Deshalb sind die Abbildungen unverbindlich.
Les caractéristiques techniques et les compositions présentées dans ce prospectus peuvent subir des variations. Les images reproduites n'ont qu'une valeur indicative.
Las características técnicas y las composiciones ilustradas en este folleto pueden sufrir variaciones. Las imágenes propuestas son solamente indicativas.

Member of VSG - Vehicle Service Group
a **DOVER** company

